

X75

Piede Orientabile con Base e Stelo in Acciaio Inox AISI 304

Levelling Foot with AISI 304 Stainless Steel Base and Stud

INOX
Stainless Steel

Cod.	A	M	B	C	H	Chiave Spanner	Carico Max Max Load daN	U.V.
A5X75/12070	75	12MA	70	109	26	10	1700	8
A5X75/14108	75	14MA	108	148	26	12	2400	8
A5X75/16058	75	16MA	58	102	26	13	2400	8
A5X75/16119	75	16MA	119	163	26	13	2400	8
A5X75/16145	75	16MA	145	189	26	13	2400	8
A5X75/16201	75	16MA	201	245	26	13	2400	8
A5X75/18157	75	18MA	157	201	26	15	2400	8
A5X75/20107	75	20MA	107	153	26	17	2400	8
A5X75/20135	75	20MA	135	181	26	17	2400	8
A5X75/20157	75	20MA	157	203	26	17	2400	8
A5X75/20190	75	20MA	190	236	26	17	2400	8
A5X75/20238	75	20MA	238	284	26	17	2400	8
A5X75/24090	75	24MA	90	139	26	19	2400	8
A5X75/24127	75	24MA	127	176	26	19	2400	8
A5X75/24162	75	24MA	162	211	26	19	2400	8
A5X75/24201	75	24MA	201	250	26	19	2400	8
A5X75/30125	75	30MA	125	174	26	24	2400	8
A5X75/30185	75	30MA	185	234	26	24	2400	8



Ø75

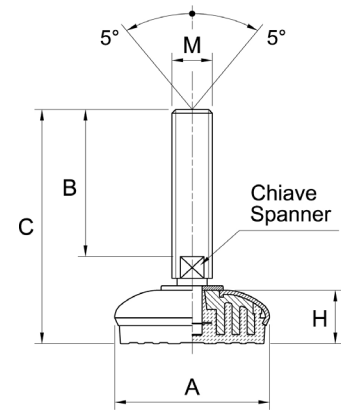

Caratteristiche

Materiale Base:

Anima interna in poliammide + FV;
rivestimento esterno in acciaio inox AISI 304; antivibrante in gomma termoplastica SEBS 55 shore colore nero.

Materiale Stelo: Acciaio inox AISI 304

Tipo Stelo: Girevole

Presentazione Prodotto:

Stelo fornito assemblato alla base

Note:

L'antivibrante costampato consente una perfetta aderenza con la base in acciaio. La conseguente assenza di cavità interne rende il piede estremamente sanificabile.

Product specification

Base Material:

Internal part made of reinforced polyamide;
external covering made of stainless steel AISI 304; anti-slip pad made of SEBS Rubber 55 shore black colour.

Spindle Material: Stainless steel AISI 304

Spindle Type: Revolving

Product Presentation:

Spindle supplied assembled to the base

Note:

The comoulded anti-slip rubber pad adheres perfectly to the steel base thus the absence of internal cavities makes the foot extremely easy to clean and sanitize.